

Title: FCD Ballot Text of ITU-T X.604 | ISO/IEC 24793-1, MMC - Framework

Source: ISO/IEC JTC 1/SC 6/WG 7 (Seok J. Koh, Maryam Roshanaei)

Status:

This document is the revised text of draft Recommendation ITU-T X.604 | ISO/IEC 24793-1 (MMC-1), which was made in the 2009 June meeting of JTC1/SC6/WG7.

It is proposed that the proposed text be submitted to the JTC1/SC6 for FCD ballot processing.

Table of Contents

1.	SCOPE	2
2.	NORMATIVE REFERENCES	2
3.	DEFINITIONS	2
4.	ABBREVIATIONS.....	3
5.	INTRODUCTION.....	3
5.1	MARKET TRENDS.....	4
5.2	NETWORK ENVIRONMENTS.....	4
5.3	RELATED STANDARDS	5
5.3.1	IETF	5
5.3.2	ITU-T AND ISO/IEC JTC1	6
5.3.3	3GPP/MBMS, 3GPP2/BCMCS AND WiMAX/MBS.....	7
5.3.4	DVB/CBMS AND OMA/BCAST	7
5.3.5	RELATIONSHIP BETWEEN MMC AND RELATED STANDARDS	8
6.	DESIGN CONSIDERATIONS.....	9
6.1	TARGET APPLICATIONS AND SERVICES.....	9
6.2	DESIGN PRINCIPLES	9
6.3	NETWORK MODELS.....	10
6.3.1	MULTICAST NETWORKS.....	10
6.3.2	OVERLAY MULTICAST NETWORKS	11
6.4	FUNCTIONAL REQUIREMENTS	11
7.	FUNCTIONAL ARCHITECTURE.....	12
7.1	FUNCTIONAL ENTITIES.....	12
7.1.1	MOBILE NODE (MN).....	12
7.1.2	MULTICAST CONTENTS SERVER (MCS)	12
7.1.3	SESSION MANAGER (SM)	13
7.1.4	MULTICAST AGENT (MA).....	13
7.1.5	LOCAL MOBILITY CONTROLLER (LMC).....	13
7.2	REFERENCE CONFIGURATION OF FUNCTIONAL ENTITIES	13
7.2.1	CONFIGURATION IN MULTICAST NETWORKS	14
7.2.2	CONFIGURATION IN OVERLAY MULTICAST NETWORKS	14
7.3	MMC FUNCTIONALITY	15
7.3.1	MULTICAST DATA TRANSPORT.....	16
7.3.2	SESSION JOIN AND USER LEAVE	16
7.3.3	TREE CONFIGURATION IN OVERLAY MULTICAST NETWORK	16
7.3.4	STATUS MONITORING	17
7.3.5	MOBILITY SUPPORT	17
8.	HIGH-LEVEL INFORMATION FLOWS.....	18
8.1	SERVICES SUBSCRIPTION AND SESSION ANNOUNCEMENT	18
8.2	MULTICAST DATA TRANSPORT.....	18
8.3	SESSION JOIN AND LEAVE.....	19
8.4	CONFIGURATION OF MMC AGENTS.....	19
8.4.1	CONFIGURATION OF LOCAL MOBILITY CONTROLLER FOR MULTICASTING	19
8.4.2	TREE CONFIGURATION FOR THE OVERLAY MULTICASTING.....	19
8.5	STATUS MONITORING	20
8.6	MOBILITY SUPPORT	20
	APPENDIX A. APPLICABILITY OF MMC PROTOCOLS TO OMA/BCAST	22
	APPENDIX B. BIBLIOGRAPHY	23

**INTERNATIONAL STANDARD 24793-1
ITU-T RECOMMENDATION X.604**

**INFORMATION TECHNOLOGY –
MOBILE MULTICAST COMMUNICATIONS: FRAMEWORK**

SUMMARY

This Recommendation | International Standard describes the framework of Mobile Multicast Communications (MMC). MMC is intended for real-time, one-to-many multicast services and applications over mobile communications networks. This Recommendation | International Standard specifies the design principles, functional architecture, and high-level information flows for MMC over wireless mobile networks.

KEYWORDS

Mobile Multicast Communication, Wireless/Mobile Network, IP Multicasting, Overlay Multicasting, Framework

FOREWORD

ISO (International Organization for Standardization) and IEC (International Electrotechnical Commission) established the specialized system for worldwide standardization. National bodies that are members of ISO or IEC participate in the development of International Standards through technical committees established by the respective organization to deal with particular fields of the technical activity. ISO and IEC technical committees collaborate in fields of mutual interest. Other international organizations -- be they government or non-government -- also take part in the work in liaison with ISO and IEC. In the field of information technology, ISO and IEC have established a joint technical committee, ISO/IEC JTC 1.

ISO/IEC 24793 consists of the following parts under the general title Information Technology — Mobile Multicast Communications:

- Part 1: Framework (ITU-T X.604 | ISO/IEC 24793-1, MMC-1)
- Part 2: Protocol over Native IP Multicast Networks (ITU-T X.604.1 | ISO/IEC 24793-2, MMC-2)
- Part 3: Protocol over Overlay Multicast Networks (ITU-T X.604.2 | ISO/IEC 24793-3, MMC-3)

1. SCOPE

This Recommendation | International Standard describes the Mobile Multicast Communications (MMC), which can be used to support a variety of multimedia multicasting services in IP-based wireless mobile networks as well as wired fixed networks. MMC targets real-time, one-to-many multicast services and applications over mobile communications networks. This implies that MMC focuses on multicast services rather than broadcast services, and that only authenticated users could be allowed in the multicast session. MMC also considers the one-to-many multicast session wherein a single multicast sender is allowed in the session rather than many-to-many multicast services. In addition, MMC is targeted in the real-time multicast session rather than the reliable multicast session; the timely delivery of multicast data is considered a key factor.

This Recommendation | International Standard specifies the MMC framework as part of the MMC standard describing the framework and functional architecture of MMC. Based on this framework, the two protocols for MMC will be developed in two parts of the MMC project: protocol over native IP multicast networks and protocol over overlay multicast networks.

2. NORMATIVE REFERENCES

The following ITU-T Recommendations and International Standards contain provisions that, through references in the text, constitute provisions of this Recommendation | International Standard. At the time of publication, the editions indicated were valid. All Recommendations and Standards are subject to revision, and parties to agreements based on this Recommendation | International Standard are encouraged to investigate the possibility of applying the most recent edition of the Recommendations | International Standards listed below. ISO and IEC members maintain registers of currently valid International Standards. The Telecommunication Standardization Bureau of the ITU-T maintains a list of currently valid ITU-T documents.

- a) ITU-T Recommendation X.603 (2004) | ISO/IEC 16512-1 (2004), Information Technology — Relayed Multicast Protocol (RMCP): Framework
- b) ITU-T Recommendation X.603.1 (2007) | ISO/IEC 16512-2 (2007), Information Technology — Relayed Multicast Protocol (RMCP): Specification for Simplex Group Applications

The following IETF standard track RFCs specify the multicast forwarding capability in IP multicast networks:

- c) IETF RFC 2236 (1997), Internet Group Management Protocol Version 2 (IGMPv2), Proposed Standard
- d) IETF RFC3810 (2004), Multicast Listener Discovery Version 2 (MLDv2) for IPv6, Proposed Standard
- e) IETF RFC 4601 (2006), Protocol Independent Multicast - Sparse Mode (PIM-SM): Protocol Specification, Proposed Standard

3. DEFINITIONS

This Recommendation | International Standard uses the terms defined in the Relayed Multicast Protocol (ITU-T Rec. X.603 | ISO/IEC 13252). The following terms are also used in this Recommendation | International Standard:

- a) **Multicast Network**
Multicast Network refers to any of the networks wherein legacy IP multicasting schemes are enabled with the help of multicast routing protocols, multicast forwarding capability of multicast routers in the networks, link-layer multicasting of the points of attachment in the network, and multicast membership signaling in the subnet such as IGMP/MLD. MMC services could be provisioned over the Multicast Network.
- b) **Overlay Multicast Network**
An overlay multicast network pertains to a network wherein legacy IP multicasting schemes are not fully supported. In this network, multicast application data are delivered using unicast transport such as TCP, UDP,

or IP-in-IP tunneling schemes. In particular, the unicast delivery of multicast data may be done in backbone networks. In the overlay multicast network, IP multicast transport may be used in a portion of the network. For example, as shown in the RMCP protocol (ITU-T X.603 | ISO/IEC 16512), subnet multicasting may be used in the end subnets where the multicast sender or receiver is located. In the overlay multicast network, multicast data may be delivered using the unicast relay of multicast agents and subnet multicasting capability. MMC services could be provisioned over the overlay multicast network.

4. ABBREVIATIONS

AAA	Authentication, Authorization, and Accounting
AS	Authentication Server
BCMCS	Broadcast Multicast Services
BWA	Broadband Wireless Access
MCS	Multicast Contents Server
ECTP	Enhanced Communications Transport Services
FMC	Fixed Mobile Convergence
IGMP	Internet Group Management Protocol
IP	Internet Protocol
IPTV	IP-based TV
MA	Multicast Agent
MBMS	Multimedia Broadcast Multicast Services
MLD	Multicast Listener Discovery
MMC	Mobile Multicast Communications
MMCF	MMC Framework
MN	Mobile Node
NGN	Next-Generation Networks
RMCP	Relayed Multicast Protocol
SM	Session Manager
SDO	Standard Defining Organization
WLAN	Wireless Local Area Network

5. INTRODUCTION

This Recommendation | International Standard deals with Mobile Multicast Communications (MMC). MMC is targeted to enable and support a variety of multimedia multicast applications and services over the wireless/mobile networks as well as the wired/fixed networks.

This document describes the MMC Framework (MMCF). Based on this framework, the two protocols required for MMC will be developed. This clause will first describe the rationale for MMC from the perspective of market trends and evolving network environments. In addition, some related works that have been made in other SDOs will be reviewed.

5.1 MARKET TRENDS

From the market perspective, the work on MMC is driven by the following observations:

a) Growth of IP-based multimedia broadcast/multicast services markets

In telecommunications markets, there is a crucial need to provide multimedia multicasting and broadcasting services all over the world. With the help of broadband networks, efficient multimedia platforms including audio/video codecs, and IP-based network transport and application technologies, the markets for IP-based multimedia broadcasting and multicasting services are expected to grow in next-generation communications networks.

Examples of these multimedia multicast/broadcast services include Internet TV (IPTV), remote education, broadcasting of special live events, etc.

b) Increasing needs of multimedia broadcast/multicast services over wireless mobile networks

The recent trend in the mobile communications industry reflects the increasing demands of multimedia multicast/broadcast applications and services over wireless/mobile networks. In fact, IP-based multimedia broadcasting/multicasting services will be some of the primary killer applications from the perspective of mobile services providers.

Examples of these mobile multicast applications/services include mobile IPTV, mobile commerce (m-commerce), and Digital Multimedia Broadcasting (DMB) using mobile devices such as cellular phone, PDA, handheld PCs, etc. These mobile multicasting services are expected to be provisioned through a variety of wireless access networks such as cdma2000, W-CDMA, Wireless LAN (WLAN) based on IEEE 802.11, and Broadband Wireless Access (BWA) based on IEEE 802.16. Most of the mobile service providers are expected to provide IP-based multimedia multicasting services over these various wireless networks.

c) MBMS and BCMCS standardizations in 3GPP and 3GPP2

Given the demand for mobile multicasting, 3GPP and 3GPP2 are working on standardization to develop the relevant protocols or schemes. In 3GPP, the “Multimedia Broadcast and Multicast Services (MBMS)” is being developed to support IP-based multimedia multicasting services in its own systems. On the other hand, 3GPP2 started to come up with standardization works on the “Broadcast & Multicast Services (BCMCS)” for their own cdma2000-based networks and systems.

5.2 NETWORK ENVIRONMENTS

In next-generation communications networks, a variety of heterogeneous access networks using different wireless/wired access technologies are expected to coexist under the same administrative domain or network operator. In this environment, those heterogeneous access networks may be interconnected with each other via the IP-based core network; thus ensuring that identical multimedia multicast/broadcast services could be provided to users regardless of the access network where the user is connected.

With this trend of Fixed-Mobile Convergence (FMC), there is a crucial need to provide multimedia multicasting services/applications over wireless/mobile networks as well as wired/fixed communications networks.

The following figure illustrates the network environment to be considered in the MMC.

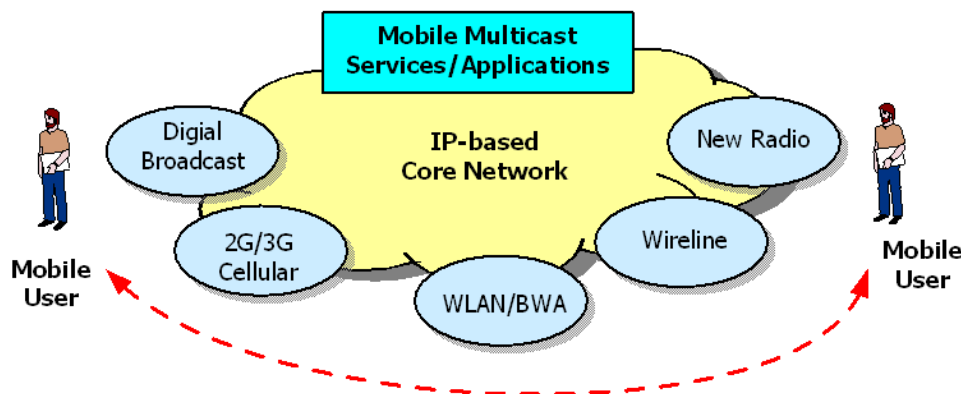

Figure 1 – Network environments in MMC

As shown in the figure above, the NGN environment is featured in the “IP-based core network” and a variety of “heterogeneous access networks.” In this scenario (figure 1), the network operator (or service provider) will provide various multimedia multicasting services/applications for users over the IP-based core network. Each (mobile) user will benefit from such comprehensive services through the various access networks. Each access network could be a fixed/wired network such as the conventional PSTN, ISDN, and Internet or a mobile/wireless network such as WLAN, BWA, and 3G cellular networks. Under the FMC feature, users shall benefit from identical multimedia multicasting services regardless of the specific access network where they are connected.

Note that the user may move around across a variety of access networks in the NGN environment. Accordingly, the issue of mobility support for mobile users needs to be addressed from the MMC perspective, i.e., seamless mobility (specifically handover) shall be supported even when mobile users move across those heterogeneous networks. The mobility issue on MMC shall deal with how to support seamless multicast services against the movement of users (terminals).

These observations suggest the need for some schemes or protocols in providing seamless mobile multicasting services under FMC and mobility environments of NGN. Such schemes or protocols shall be commonly applied for a variety of heterogeneous wireless and wired access networks regardless of the movement of users.

5.3 RELATED STANDARDS

This document seeks to design the framework of MMC. MMCF shall be designed based on existing works that have been made to date in SDOs. Thus, this clause describes the relevant works in IETF, ITU-T, JTC1, and 3GPPs.

5.3.1 IETF

As a leading SDO in the area of IP multicasting, IETF has so far developed the protocols required for multicast data transport including IGMP/MLD and multicasting routing protocols for multicast tree construction to deliver multicast data packets in the Internet.

IGMP/MLD protocols are used for signaling between multicast routers and hosts in the network. These protocols ensure that network routers can determine whether there is any multicast user (specific to the group IP address); this information will in turn be used by multicast routers to construct the multicast tree using the multicast routing protocols. To date, the following IGMP/MLD protocols have been developed:

- Internet Group Management Protocol (IGMP) for IPv4: IGMPv2, IGMPv3
- Multicast Listener Discovery (MLD) for IPv6: MLDv1, MLDv2

Multicast routing protocols are used as signaling protocols to construct a multicast tree for a specific multicast IP address that will require multicast network routers to configure the associated multicast forwarding table as the routing path for multicast data packets. To date, the following multicast routing protocols have been developed:

- Distance Vector Multicast Routing Protocol (DVMRP)

- Core-Based Tree (CBT)
- Protocol-Independent Multicast – Dense Mode (PIM-DM)
- Protocol-Independent Multicast – Sparse Mode (PIM-SM)
- Source-Specific Multicast (SSM), which uses IGMPv3 (IPv4) or MLDv2 (IPv6)

In the IETF, further works are in progress for works on the deployment of IP multicasting (e.g., IGMP snooping in the MBONED WG). Based on the discussion above, works made in the IETF can be summarized as follows:

Table 1 – IETF protocols related to IP multicasting

Technical Areas	Protocols (year)	Reference (RFC)
IGMP/MLD	IGMPv2 (1997)	RFC 2236
	IGMPv3 (2002)	RFC 3376
	MLDv1 for IPv6 (1996)	RFC 2710
	MLDv2 for IPv6 (2004)	RFC 3810
Multicast Routing Protocols	DVMRP (1988)	RFC 1075
	CBT (1997)	RFC 2189
	PIM-SM (1998)	RFC 2362
	PIM-DM (2005)	RFC 3973
	SSM (2003)	RFC 3569

5.3.2 ITU-T AND ISO/IEC JTC1

The main focus in JTC1/SC6 and ITU-T SG17 is on the protocols that can provide the reliable multicast transport and QoS management for IP multicasting in networks as described in the Enhanced Communications Transport Protocol (ECTP). The ECTP is a reliable multicast protocol designed to support Internet multicast applications running over multicast-capable networks. ECTP may be provisioned over UDP; it is designed to support tightly controlled multicast connections in simplex, duplex, and N-plex applications.

ECTP consists of the following parts:

- a) ECTP-1: Simplex multicast transport (ISO/IEC 14476-1 | ITU-T X.606)
- b) ECTP-2: QoS management for simple multicast transport (ISO/IEC 14476-2 | ITU-T X.606.1)
- c) ECTP-3: Duplex multicast transport (ISO/IEC 14476-3 | ITU-T X.607)
- d) ECTP-4: QoS management for duplex multicast transport (ISO/IEC 14476-4 | ITU-T X.607.1)
- e) ECTP-5: N-plex multicast transport (ISO/IEC 14476-5 | ITU-T X.608)
- f) ECTP-6: QoS management for N-plex multicast transport (ISO/IEC 14476-6 | ITU-T X.608.1)

The JTC1/SC6 and ITU-T SG17 groups are also developing the Relayed Multicast Protocol (RMCP). The RMCP is designed to ensure that multicast applications and services can be realized over the current Internet environments wherein IP multicast has not been deployed completely. Also known as application-level multicast, the RMCP is a multicast data transport protocol used for multicast applications wherein intermediate Multicast Agents (MA) are employed for relaying multicast data from a sender to many receivers over unicast networks as shown in the following figure:

RMCP consists of the following parts:

- a) RMCP-1: RMCP framework (ISO/IEC 16512-1 | ITU-T X.603)
- b) RMCP-2: RMCP for simple group applications (ISO/IEC 16512-2 | ITU-T X.603.1)
- c) RMCP-3: RMCP for N-plex group applications (ISO/IEC 16512-3 | ITU-T X.603.2)

5.3.3 3GPP/MBMS, 3GPP2/BCMCS, AND WiMAX/MBS

For the provisioning of multimedia multicast and broadcast services over wireless mobile systems, 3GPP is developing the “Multimedia Broadcast and Multicast Services (MBMS)” that can be used to support IP-based multimedia multicasting services in its own W-CDMA access networks and systems.

For the MBMS subsystem, 3GPP defines a new functional entity called “Broadcast and Multicast - Service Center” (BM-SC) and two new interfaces: Gmb for the control plane (authorization and management) and Gi for the user plane (IP packet transmission). BM-SC is responsible for overall session management and multicast data transport in the 3GPP system. The MBMS of 3GPP is featured in the service-oriented, security-oriented multicast framework in 3GPP2’s own networks and systems using legacy IP multicast protocols as much as possible.

The 3GPP documents associated with MBMS include:

- a) 3GPP TS 22.246, MBMS User Services
- b) 3GPP TS 23.246, MBMS Architecture
- c) 3GPP TS 25.346, MBMS in RAN: Stage 2
- d) 3GPP TS 26.346, MBMS Protocols and Codecs
- e) 3GPP TS 33.246, Security of MBMS

On the other hand, 3GPP2 started to pursue standardization in “Broadcast & Multicast Services (BCMCS)” to provide broadcast/multicast services and applications over its own cdma2000 systems.

Similar to the MBMS of 3GPP, BCMCS plans to design a secure multicast in cdma2000 networks and to develop some technical specifications for provisioning multimedia multicasting services over 3GPP2’s own networks and systems using legacy IP multicast protocols as much as possible. BCMCS can be regarded as the subsystems for adding the services-specific, security-oriented features to the IETF multicasting protocols.

For this purpose, BCMCS introduces new entities together with the security framework: BCMCS Controller for control purposes and BCMCS Supporting Node (BSN) for data transport purposes.

The 3GPP2 documents associated with BCMCS include:

- a) 3GPP2 S.R0030-A, Broadcast/Multicast Services – Stage 1
- b) 3GPP2 S.S0083-A, Broadcast Multicast Security Framework
- c) 3GPP2 X.S0022, BCMCS in cdma2000 wireless IP network
- d) 3GPP2 A.S0019, Interoperability Specification for BCMCS
- e) 3GPP2 C.S0054, cdma2000 High-Rate BCMCS Packet Data Air Interface Specification

The WiMax forum has been developing a set of standards for IEEE 802.16-based wireless access technology, which is also known as Wireless Broadband (WiBro). In particular, the network working group of the WiMax forum is considering the Multicast Broadcast Services (MBS) that can be used for WiMax-based wireless access networks. MBS is aimed at developing the specification that enables multicast and broadcast transmissions over WiMax-based wireless access networks. For this purpose, two kinds of MBS zones are being considered: embedded MBS and standalone MBS, which will be additionally defined in the MAC frame. In the embedded MBS zone, the downlink (DL) frame will be provided along with the unicast service; the standalone MBS will contain the entire DL frame dedicated to MBS transmissions.

5.3.4 DVB/CBMS AND OMA/BCAST

In the Digital Video Broadcasting (DVB) forum, a new broadcasting technology that includes DVB-H (handheld) devices and associated broadcasting transmission facilities has been developed. DVB-H can be viewed as a technology specific to broadcasting rather than telecommunications. The DBV forum is also developing the system-wide standard specifying the management and operating platform to provide broadcast and multicast services over 3G cellular networks as well as DVB-H-based broadcasting networks i.e., Convergence of Broadcast and Mobile Services (CBMS).

On the other hand, the Open Mobile Alliance (OMA) forum is defining a set of standards for enabling mobile broadcasting and multicasting services called “BCAST.” The OMA/BCAST can also be a kind of system-wide standard

that defines the framework of mobile multicasting and broadcasting services over wireless networks such as 3GPP/MBMS and 3GPP2/BCMCS as well as the broadcasting network such as DVB-H.

5.3.5 RELATIONSHIP BETWEEN MMC AND RELATED STANDARDS

Figure 2 summarizes the relationship between the MMC standards and other standards related to mobile multicasting.

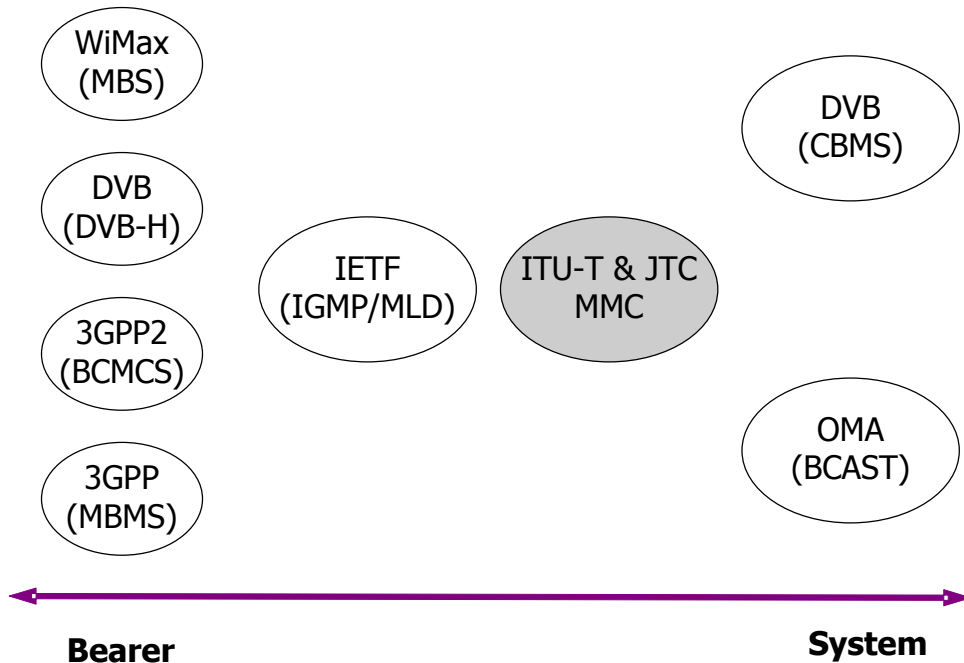

Figure 2 – Relationship between MMC and other related standards

As shown in the figure above, the other standards related to mobile multicasting can be classified into three categories: multicast-enabling network technologies as the bearer (3GPP/MBMS, 3GPP2/BCMCS, WiMax/MBS, DVB/DVB-H), IP multicast protocols such as IGMP/MLD as defined in the IETF, and system-wide standards for defining the framework of mobile multicast services (OMA/BCAST, DVB/CBMS).

The standards for bearer capability specify how to enable multicast transmissions over the existing wireless and mobile networks. For example, the 3GPP/MBMS standard seeks to define the components of 3GPP-based wireless access networks for supporting the multicast transmission over the air interface; 3GPP2/BCMCS is for multicasting over 3GPP2-based radio access networks. WiMax/MBS is a technology designed to deliver multicast data over the IEEE 802.16-based wireless networks. In contrast, DVB/DVB-H is a broadcasting network.

The IETF has come up with several protocols supporting multicast routing and forwarding over the Internet such as IGMP/MLD and multicast routing protocols. Those protocols can also be used as IP-layer protocols over a variety of wireless networks such as MBMS, BCMCS, MBS, and DVB-H.

The OMA/BCAST and DVB/CBMS can be viewed as system-level standards that define the framework of multicast and broadcast services over several wireless/mobile networks. Such standard consists of a set of various components including service provisioning, stream distribution, service/contents protection, roaming, and handover. Note that such framework standards define the service and session management for multicasting services as well as interfaces with multicast data transport using IGMP/MLD and multicast routing protocols over wireless access networks such as MBMS, BCMCS, etc.

On the other hand, MMC protocols will be running on top of IETF multicast-related protocols as well as a variety of wireless and broadcasting networks. Based on such IP-based protocols and networks, the MMC protocols will specify the session and membership management for multicast sessions and overlay multicasting functionality as described in the MMC-3 specification. MMC protocols also seek to provide the mobility functionality for mobile terminals such as handover.

In this respect, note that the MMC-2 and MMC-3 protocols can be used as the component protocols of OMA/BCAST or DVB/CBMS for supporting multicast transmission and services in wireless and broadcasting networks. For example, the MMC-2 or MMC-3 protocol may be incorporated into the framework of OMA/BCAST or DVB/CBMS standard to enable the session and membership management of multicast sessions and handover support for mobile terminals in multicast networks. More detailed usage scenarios of MMC protocols for OMA/BCAST and DVB/CBMS are described in Appendix A of this specification.

6. DESIGN CONSIDERATIONS

This Recommendation | International Standard seeks to design the framework of MMC, which can be used to support a variety of multimedia multicast applications and services over wireless mobile networks as well as fixed networks in NGN environments.

For this purpose, this clause discusses the considerations in designing MMCF.

6.1 TARGET APPLICATIONS AND SERVICES

The MMCF shall be designed to support IP-based multimedia multicast applications with the following characteristics:

a) Multicast applications/services

The MMCF will be targeted for multicast applications and services rather than broadcast applications and services. Multicast-based services will allow only the authenticated, authorized users to use the MMC services, whereas broadcast applications/services may be provided to any user without any authentication and authorization procedure.

To support the provision of MMC services to authenticated, authorized users only, MMCF shall be interworking with legacy AAA schemes. As such, MMCF shall also require appropriate steps for users such as “service subscription” and “session join.”

b) One-to-many multicast applications/services

The MMCF will also be targeted for one-to-many multicast applications rather than many-to-many multicast ones. One-to-many multicast services shall consist of a single data sender -- which is also called Multicast Contents Server (MCS) -- and many receivers (multicast users or clients). In other words, only a single sender shall be allowed in the multicast session.

Note that most of the commercial multicast applications and services are based on the one-to-many multicast scenario. The case of many-to-many application is intended for further study.

c) Real-time multicast applications/services

The MMCF shall be designed to support one-to-many, “real-time” multicast applications rather than non-real-time and/or reliable multicast applications. Note that a real-time multicast application focuses on the delivery of data in a timely manner, whereas a reliable multicast application exerts efforts to perform reliability control (e.g., error recovery through the retransmission of lost/corrupted packets) as shown in the ECTP protocol (ISO/IEC 14476 | ITU-T X.606).

MMCF is targeted for real-time multicast applications such as IPTV multicasting or live broadcasting of live events, since timely delivery is preferred to reliable delivery for such real-time applications and services. In MMCF, reliability control is assumed to be executed in the application itself.

6.2 DESIGN PRINCIPLES

This document describes the design of MMCF for MMC services and applications over wireless mobile networks as well as fixed communications networks. Based on MMCF, the development of one or more associated control protocols for MMC is planned.

For this purpose, the MMCF shall be designed based on the following design principles:

a) Generic IP-based control schemes for MMC

The MMC shall operate on the IP-based network. Accordingly, MMCF shall be designed to integrate the existing IP-based schemes and protocols (e.g., AAA, multicast routing protocols) required for the realization of MMC services.

Note that MBMS and BCMCS systems are based on their own 3GPP- and 3GPP2-specific access systems rather than on the generic IP-based scheme. On the other hand, MMCF shall be designed to ensure that MMC-related protocols could be generically and commonly used on IP-based mobile networks such as WLAN (IEEE 802.11) or BWA (IEEE 802.16).

b) Flexible integration of legacy multicast applications with MMCF

The MMCF is mainly targeted to develop a new “control” protocol used for MMC applications over mobile networks. Accordingly, all kinds of existing legacy multicast applications shall be usable together with the MMC protocol without further modifications.

c) Interworking with the conventional protocols for security and authentication/authorization

For commercial deployment of mobile application services, security is an essential issue on the service provider side. In particular, authentication and authorization schemes (e.g., AAA servers) for session users will be required through the session join phase. In addition, any security scheme such as IPSEC or TLS may be used to secure MMC services. As such, associated legacy schemes/protocols shall be interworking with the MMC protocol.

6.3 NETWORK MODELS

The MMCF is designed for multicast delivery networks wherein multicast data transport may be realized using IP multicast transport (with the help of IGMP/MLD) and multicast routing protocols or using the overlay multicast transport (with the help of the RMCP).

More specifically, the MMC considers the two types of networks for multicast data transport: multicast network and overlay multicast network.

6.3.1 MULTICAST NETWORKS

The following figure shows the multicast transport network model using IP multicast:

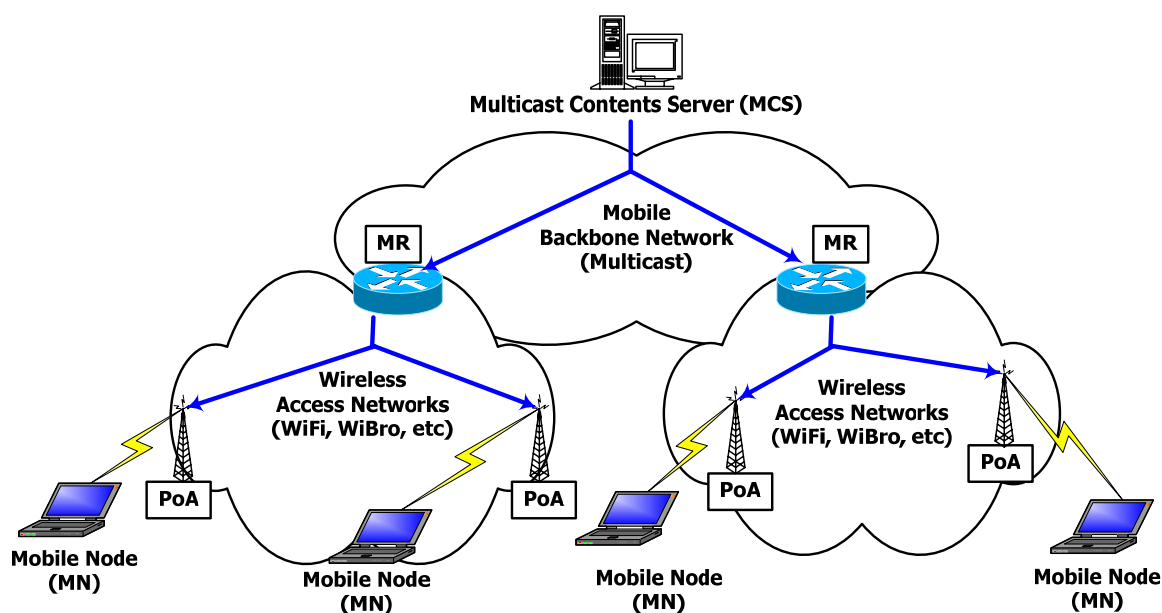

Figure 3 – Multicast data transport in MMC networks

As shown in the figure above, the MMC network consists of a backbone network (administration by the service provider) and a variety of wireless access networks. In this MMC network, multimedia data shall be delivered in real time from the Multicast Contents Server (MCS) to Mobile Nodes (MN).

For the delivery of multicast data, the networks shall be equipped with several Multicast Routers (MR) and Points of Attachment (PoAs) in the wireless access network. For the IP multicast transport, multicast routing protocols are supported between MRs; IGMP/MLD protocols shall be used between MR and MNs.

6.3.2 OVERLAY MULTICAST NETWORKS

In networks wherein IP multicast has not been deployed, overlay Multicast may be used for the delivery of multicast data in the network. As such, RMCP may be used to configure an overlay multicast tree in the networks. The following figure shows the overlay multicast:

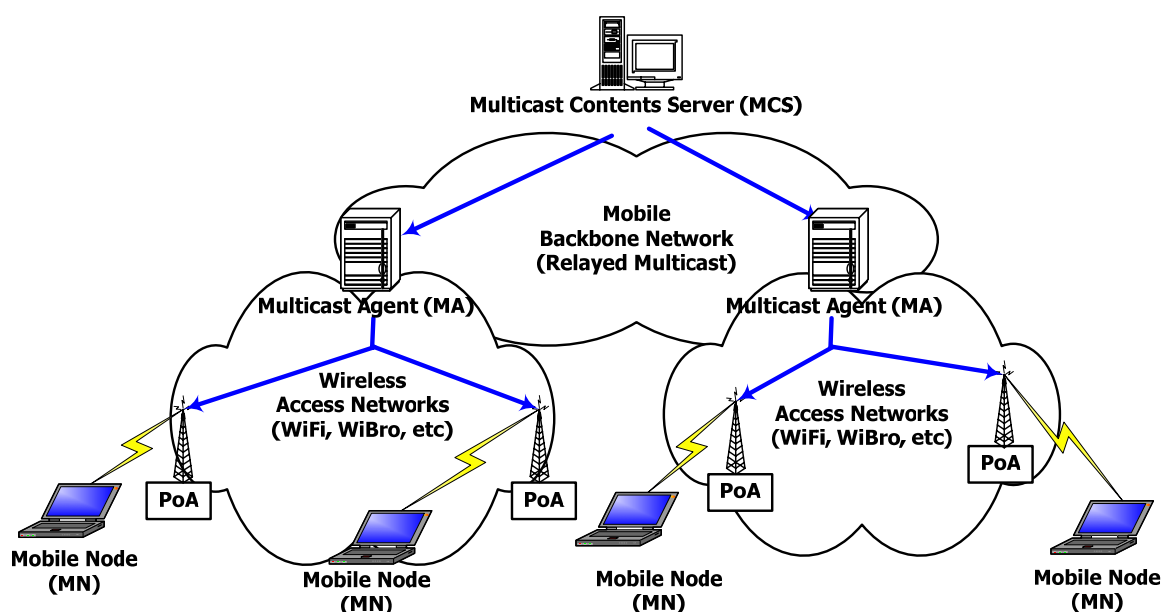

Figure 4 – Overlay multicast data transport in MMC networks

As shown in the figure above, one or more Multicast Agents (MAs) will be deployed for overlay multicasting in the network. Each MN will receive the multicast data of MCS from one of the MAs using unicast or subnet multicast.

6.4 FUNCTIONAL REQUIREMENTS

For multicast transport over the Internet, IETF has so far developed several protocols for IP multicasting including IGMP/MLD and multicast routing protocols such as DVMRP, CBT, PIM, and SSM. With the help of these protocols, networks providers will realize the deployment of multicast-capable networks.

Nevertheless, there is still a need for multicast session control and management schemes to provide commercial multicast services including session management and status monitoring. In addition, in the case of mobile multicasting, a control scheme for mobility support for mobile users shall be required.

Accordingly, to support mobile multimedia multicast applications and services over wireless mobile networks, MMC shall be designed based on the following functional requirements:

- a) Control functionality for mobile multicast sessions

The MMC shall be realized with the help of conventional IP multicasting protocols such as IGMP/MLD, multicast routing protocols made in IETF, and RMCP made in ITU-T and JTC1. Accordingly, MMCF shall provide the “control” and “management” functions for the MMC sessions as well as the multicast data transport functionality.

These control functions may include “session join” for a new joining user, “membership monitoring” for active users, QoS monitoring for the data packets received by end users, etc.

b) Support of membership monitoring

The MMCF shall be designed to support the monitoring of active session membership of users for each multicast session. Such monitored information could be used for charging and billing by the contents providers.

c) Support of QoS monitoring in wireless environments

Note that wireless links generically have lower quality than wired links. Accordingly, mobile users may be affected by the quality of services for mobile application services. In this context, MMCF shall be designed to provide the monitoring of QoS as perceived by end users. Such monitored QoS information may be used by contents servers to adjust the data transmission rate. For example, the MPEG-based transcoding or SVC (Scalable Video Coding) techniques could be used to reflect on the QoS status of end users. The monitored QoS information may also be used by the content providers to charge the end users for the use of contents/services.

d) Support of the mobility of mobile terminals

The mobility of a mobile terminal is one of the key issues to be dealt with for the MMC services. In mobile networks, each MN user tends to move into other networks; thus changing a new access point and the IP address in the newly attached network. The MMCF shall be designed to support such mobility or handover for the mobile terminals during the MMC session. With the help of this handover control functionality, mobile users could continue the multicast session seamlessly.

e) Support of the authentication and authorization of multicast users

The MMCF shall be designed to support the AAA functionality for the multicast session. For this purpose, the MMC shall be able to interwork with legacy AAA servers and/or user profile databases, etc. These servers and databases may be used for the authentication and authorization of the newly joining multicast user.

7. FUNCTIONAL ARCHITECTURE

7.1 FUNCTIONAL ENTITIES

In this clause, a set of functional entities for MMC are described; they shall be involved with the multicast transport and control functionality required for the MMC sessions.

7.1.1 MOBILE NODE (MN)

A Mobile Node (MN) represents a multicast receiving user for a mobile multicast application session. MN will receive the MMC application data services from the Multicast Contents Server (MCS) with the help of multicast or overlay multicast transport in the networks. Each MN will join an MMC session by contacting the Session Manager (SM).

Each MN shall perform the following operations for an MMC session:

- Service subscription to the MMC services before an MMC session is activated;
- Joining and leaving an MMC session by contacting SM;
- Status reporting (membership and QoS) to the Session Manager;
- Mobility (handover) support by movement in the network.

For the MMC session, only the authenticated or pre-subscribed users will be allowed; this will be checked in the session join phase.

7.1.2 MULTICAST CONTENTS SERVER (MCS)

The Multicast Contents Server (MCS) is a single multicast data sender in an MMC session. When an MMC session begins, MCS starts to send multicast data to MNs using multicast or overlay multicast transport.

7.1.3 SESSION MANAGER (SM)

The Session Manager (SM) is a functional entity that is responsible for the overall control operations for an MMC session. SM shall be interworking with the corresponding MCS for the MMC session; it may or may not be co-located with the MCS.

SM shall provide the following control operations for the MMC session:

- Session creation and termination by interworking with MCS through which SM will keep the list of active sessions at the time;
- Response to the request of session join from MN; in this phase, SM may perform appropriate authentication and authorization procedures with the AAA server;
- Status monitoring for active membership and perceived QoS of MNs.

The authentication and authorization step for a newly joining MN may be implemented by interworking with an appropriate AAA server (not covered by the scope of MMC).

SM may be implemented either on the same machine with MCS or separately on a different machine. Note that SM and MCS perform different functionalities; SM manages the overall control functionality for the MMC session, whereas MCS is the multicast sender in the data transport plane.

7.1.4 MULTICAST AGENT (MA)

This entity is used to relay multicast data from MCS to MNs in the overlay multicast network. In overlay multicast networks, some MAs will be deployed in the network or dynamically configured using RMCP protocol mechanisms. In MMC, each MA performs the control operations (e.g., tree configuration, status monitoring) as well as data transport operations (relaying multicast data from the upstream MA to the downstream MAs). MA can be classified into MMA (MA for mobile user) and MA (MA for fixed user). Details of MAs are described in the RMCP specification.

7.1.5 LOCAL MOBILITY CONTROLLER (LMC)

This entity is used in the multicast network only -- not in overlay multicast -- to control the mobility of MNs locally in the access network. The Local Mobility Controller (LMC) is used to manage locally the session in the access network for the enhancement of scalability of the MMC functional operations. For this purpose, one or more LMCs may be deployed in the network. The deployment of LMC for each access network (one for each IP subnet) is recommended.

For session management, SM may assign an appropriate LMC to the MN contacting SM to join an MMC session after processing the session join procedure. Afterward (i.e., during the session), MN will contact LMC instead of SM for all MMC operations.

In particular, LMC will perform the following control operation for MMC:

- Status monitoring of active membership QoS;
- Mobility (handover) support for the moving MNs during the session.

During the session, the LMC is responsible for the control operations (status monitoring and mobility support) by interworking with MNs. The monitored status information on the session and MNs will be delivered to SM. Note that LMCs are used for enhancing the scalability of the MMC scheme. More MNs mean higher control overhead on the SM end. In particular, when periodic messages are exchanged between SM and a large number of MSs, the control overhead will hardly be negligible.

7.2 REFERENCE CONFIGURATION OF FUNCTIONAL ENTITIES

This clause provides a sample reference configuration of the MMC functional entities described in the previous clause. In the configuration examples, the MMC network is assumed to be capable of multicast data transport using IP multicast or overlay multicast.

7.2.1 CONFIGURATION IN MULTICAST NETWORKS

The figure below shows a sample network configuration of the MMC functional entities: MN, SM, MCS, and LMC. Note that network entities such as multicast routers are hidden in this figure.

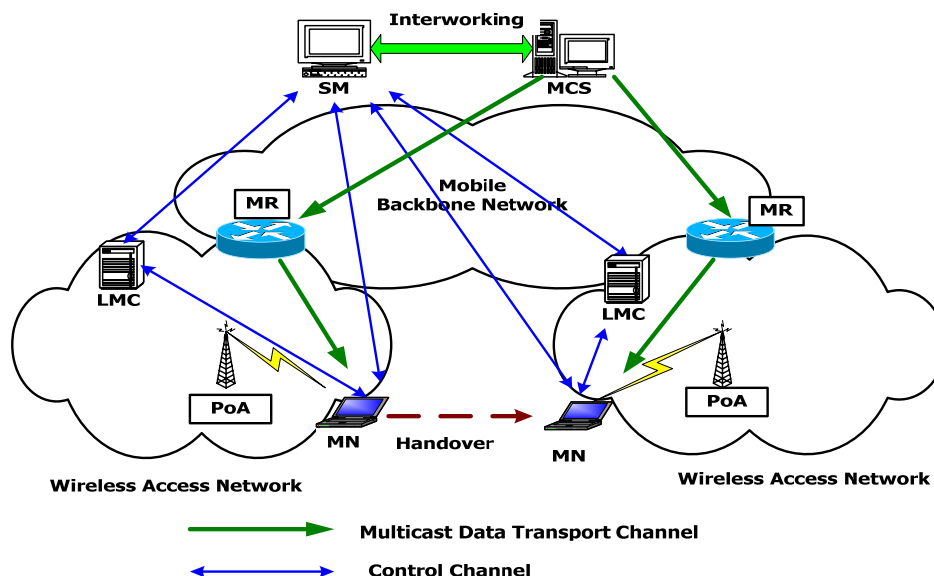

Figure 5 – Reference configuration of MMC functional entities in multicast networks

As shown in the figure above, data transport in multicast networks will be done between the Multicast Contents Server (MCS) and Mobile Nodes (MNs) with the help of Multicast Routers (MRs) in the network. On the other hand, MMC control operations including Session Join, Status Monitoring, and Mobility Support are performed between the Session Manager (SM), Local Mobility Controller (LMCs), and MNs. SM shall be interworking with MCS using a dedicated channel for MMC operations (not covered by the scope of MMC).

In Session Join, each MN will contact SM. For its part, SM informs MN of the corresponding LMC for MN. MCS will transmit multicast data to MNs over multicast networks. In Session Monitoring, each MN gives status report messages to LMC for aggregation and forwarding to SM.

For mobility support, an MN detecting its movement will inform LMC for mobility control. MN's movement types include the change of PoA (at the link layer) or MR (IP layer). The information on such movement shall be used to support seamless handover by LMCs, with LMC interworking with the neighboring LMC for this purpose.

7.2.2 CONFIGURATION IN OVERLAY MULTICAST NETWORKS

The figure below shows a sample network configuration of the MMC functional entities over overlay multicast networks including MCS, MA, MMA, MN, and SM. MA can be categorized by Mobile MA (MMA) in the wireless access network and MA in the relayed multicast backbone network. As shown in the figure below, one MMA can handle one or more wireless access networks. Note that network entities such as multicast routers are not shown in the figure, and that MA can be implemented as end-system, server, or hardware set-top box. The manner of implementing MA is not covered by the scope.

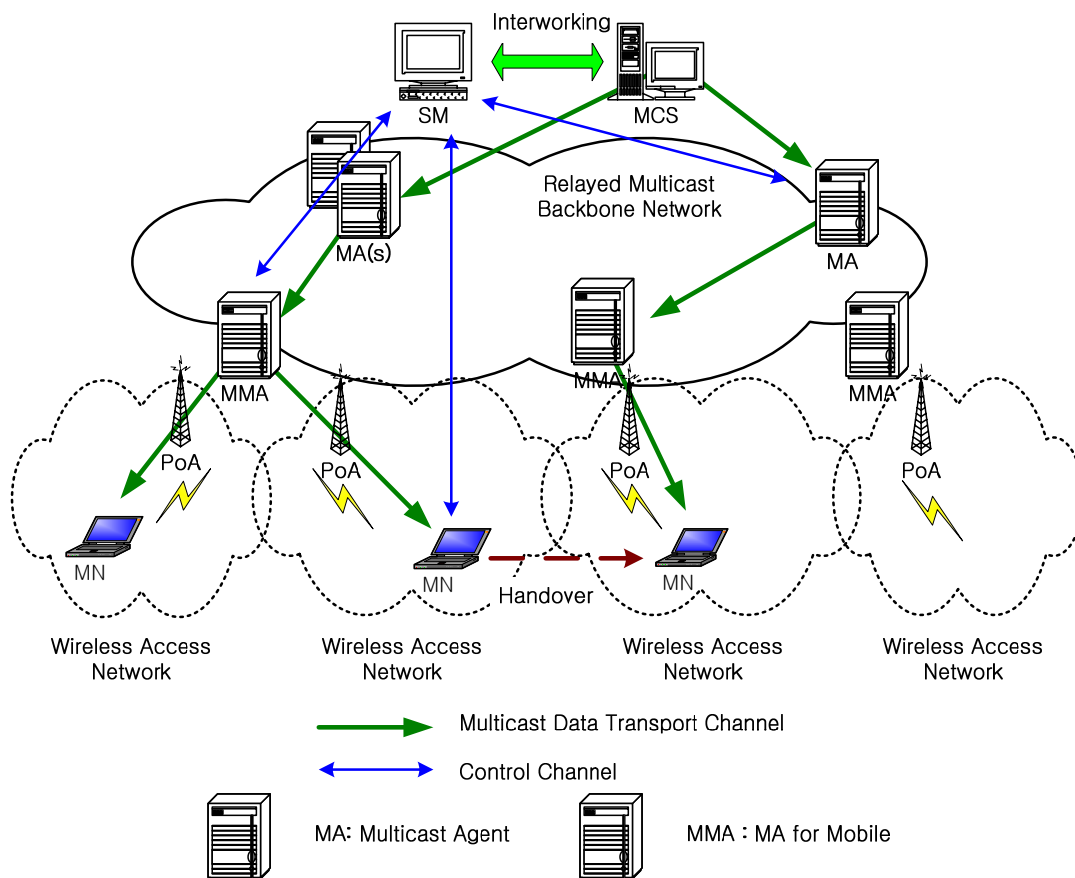

Figure 6 – Reference configuration of MMC functional entities in overlay multicast networks

As shown in the figure above, data transport in multicast networks will be done between the Multicast Contents Server (MCS) and Mobile Nodes (MNs) with the help of Multicast Agents (MAs) in the network. On the other hand, MMC control operations such as Session Join, Status Monitoring, and Mobility Support are performed between the Session Manager (SM), MMC, and MNs. SM shall interwork with MCS using a dedicated channel for MMC operations (not covered by the scope of MMC).

In Session Join, each MN will contact SM. For data delivery purposes, SM gives some information to MA regarding the corresponding MNs; for control purposes, SM informs MN of the corresponding MMAs. MCS will transmit multicast data to MNs over relayed multicast networks. In Session Monitoring, each MN gives status report messages to SM or to MMC for aggregation and forwarding to MA and SM.

For mobility support, an MN detecting its movement changes MMA. It will then contact the new MMC for mobility control. The types of movement for MN include the change of PoA (at the link layer) or change of MMA (over an IP layer). The information on such movement shall be used to support seamless handover by MMCs, with MMC interworking with the neighboring MMC for mobility control.

7.3 MMC FUNCTIONALITY

In MMC, each MN shall subscribe to specific MMC services (e.g., IPTV services). Each MMC service may include a pre-configured set of MMC sessions (or channels). In other words, MMC services may provide a group of multicast sessions and channels. For example, IPTV services may provide several IPTV channels for the users; each channel may also deliver a set of TV programs (sessions) depending on a pre-configured program schedule.

The information on the subscription of individual users to the configured MMC services shall be recorded in an appropriate database (e.g., user and services profile), which shall in turn be used in Session Join to check whether a specific MN is allowed and authorized for the use of the services or session.

In MMC, such information (with database) is assumed to be configured into the database and referred to by AS in the Session Join phase. The database shall have the information on mapping between MN and a specific session (services). Services Subscription may be performed online or offline between the service provider and promising MNs before the session starts.

The Services Subscription may include Session Announcement via out-of-band signaling (e.g., via Web announcement) as well as an appropriate subscription step (e.g., online user/service registration). The more detailed mechanisms for Service Subscription and Session Announcement are not covered by the scope of MMC.

The MMC will be designed to support the following functionality:

- Multicast data transport;
- Session Join and Leave;
- Status monitoring for active membership and QoS;
- Mobility support by handover of MN.

7.3.1 MULTICAST DATA TRANSPORT

When an MMC session starts, the MCS begins to transmit multicast data to MNs that have joined the session as per the pre-configured session (program) schedule, i.e., “Session Start.” Multicast data transport will be performed using IP multicasting or overlay multicasting. Upon completion, multicast data transport may stop the session, i.e., “Session Stop.”

In MMC, SM shall be informed of session-specific information (e.g., session start and stop, schedule of multicast data delivery) via an out-of-band channel with MCS.

7.3.2 SESSION JOIN AND USER LEAVE

When an MMC session starts (i.e., multicast data transport begins), the subscriber MNs will join the MMC session to receive data (contents) from MCS. When a session starts, MN will join the session by sending join request messages to SM. For its part, SM may accept the join request by referring to the relevant AAA server together with the associated user profile database. In MMC, the Session Join operation will be executed only between SM and MN.

After joining the session successfully, each MN can receive the multicast data packets sent by MCS. On the other hand, the additional MMC functional entity could be assigned to MN (MA or LMC).

In the overlay multicast network, MA or MMA will be dynamically or statically assigned to MN, i.e., “Tree Configuration.” MA will relay multicast data from MCS to MNs. Depending on the tree configuration scheme, more than one MA may be involved in relay multicasting. In other words, two or more tree levels could be configured along the path from MCS to MN. In the multicast network, LMC will be assigned to MN for the purpose of status monitoring and mobility support.

Note that some MNs may leave the session before the session stops.

7.3.3 TREE CONFIGURATION IN THE OVERLAY MULTICAST NETWORK

This clause describes how a data delivery tree is configured and managed in the relayed multicast network.

For the first time, SM generates new session information that includes the characteristics of media, session, authentication-related information, etc. In addition, SM waits for the subscription of MA and MN; MA can be classified into fixed MA and MMA.

MA and MN will subscribe to SM. Prospective MNs and MAs are assumed to have already been informed of the location of SM. For its part, SM responds to the subscription request by checking whether the requester is qualified. If the subscription is successful, a list of MAs is obtained from SM. Based on the information of the parent MAs, MN chooses its best parent and subsequently connects the chosen MA as its upstream MA.

After the successful join, MN can begin to receive application data from the sender (MCS) by invoking its data transport module. Any MN wishing to leave the session may notify its parent MMA.

Once a data channel has been established successfully between MN and its parent MA (MMA), some periodic request and response messages will be exchanged between the two peers (between MN and MMA or between MA and MMA). These operations are done for status monitoring and tree maintenance. If it detects that one of the downstream peers failed, an upstream peer will stop data transmission to the downstream peer in question.

The topology of the relayed multicast tree may be changed during the session by a failure in network connection. The change of the tree configuration may induce path failure or path loop; hence the need for all MAs to maintain the data delivery path in the tree. For tree maintenance, the following fault detection mechanisms can be used:

- Loop detection & avoidance;
- Partitioning detection & recovery;
- Parent switching.

7.3.4 STATUS MONITORING

After the session starts, SM and MNs shall perform Status Monitoring probably together with intermediate MAs or LMCs. The status information includes the active membership (i.e., a list of active MNs for the session) and QoS status (e.g., how much data loss or throughput each active MN has experienced for the multicast data).

To collect such status information, some control messages may be periodically exchanged between SM, MA/LMC, and MN. Those status report messages will include the following information:

- Membership ID of the MN;
- QoS measurements such as throughput, delay, packet loss rate, etc.

In case of overlay multicasting, the SM will monitor the session status such as membership dynamics and QoS as perceived by MNs. For this purpose, the status report request and its response are exchanged among SM, MAs, and MN. The functions for status monitoring in overlay multicasting include status reporting on a data channel such as data throughput and tree membership with the tree topology information.

7.3.5 MOBILITY SUPPORT

Unlike the conventional multicast scheme, MMC is characterized by the support of mobility (handover) of MN. In mobile networks, each MN may move its location in the network during the MMC session, i.e., “handover.” MMC shall support such mobility by providing seamless services against the movement of MNs.

The type of handover by movement is classified into the Link-layer handover (L2 handover) and Network-layer handover (IP handover). L2 handover occurs when MN changes its PoA in the network, whereas L3 handover is associated with the change of IP subnet (and change of the IP address of MN). Typically, L3 handover will include the L2 handover in mobile networks.

The IP handover can also be divided into the following two scenarios:

- a) Horizontal handover within the homogeneous (same) access network (e.g., within the WiBro network);
- b) Vertical handover across heterogeneous (different) access networks (e.g., between WiBro and WLAN).

In the horizontal handover, an MN moving into another subnetwork region may change its physical PoA in the mobile network and/or change its IP address. In this case, MN is required to report this handover event to its associated MMC agents such as MA or LMC. This report message may include information on the new PoA and IP address in the new network. Note that this report message could ensure that MN does not need to perform the authentication process again after moving into the new network.

In the vertical handover, MN may have multiple network interfaces. In other words, MN will be in multi-homing state in the overlapping region during the handover. The MMC protocol shall be designed to support the handover of MN, which includes the L2/L2 handover and horizontal and vertical handover.

In case of overlay multicasting, mobility control operations include the detection of the leaf MN’s movement and seamless handover for MN. To detect the movement of a leaf MN, some additional functions may be used such as link-layer triggers. Supporting seamless handover for MN requires finding a new MMA as quickly as possible. After or during the handover of MN, each MN is required to subscribe to the new MMA and to leave the current MMA as soon as possible.

8. HIGH-LEVEL INFORMATION FLOWS

Based on the MMC functional architecture described so far, this clause describes the high-level information flows between the MMC functional entities. The detailed messages and procedural flows shall be described in each of the MMC protocol specifications.

8.1 SERVICES SUBSCRIPTION AND SESSION ANNOUNCEMENT

To benefit from MMC services, each promising user shall first subscribe to the specific services provided by the service provider. MMC services may consist of a group of MMC sessions (programs) in the form of a services package. This operation can be regarded as a services contract between the service provider and users. As per the predefined session schedule, the service provider shall announce the specific sessions to the users.

In the services subscription phase, the service provider shall register the subscription-specific information with the associated user/services profile database. This database will be used for the authentication process in the session join phase.

As per the pre-configured session (program) schedule, the service provider shall announce the information on specific sessions in the session announcement, which may specify the following session-specific information:

- Session ID;
- Start/Stop time of the session;
- IP address (and port number) of the SM managing the session;
- Others such as the specific coding scheme on the application services, etc.

As an example of IPTV services, this information may be delivered to the users through the Electronic Program Guide (EPG). The detailed mechanisms for Services Subscription and Session Announcement are outside the scope of the MMC.

8.2 MULTICAST DATA TRANSPORT

MCS will start multicast data transport for an MMC session as per the predefined program schedule. MCS may use the IP multicast or overlay multicast for multicast data transport and will stop multicast data transport for an MMC session as per the predefined program schedule.

The following figure shows the data flows for multicast data transport:

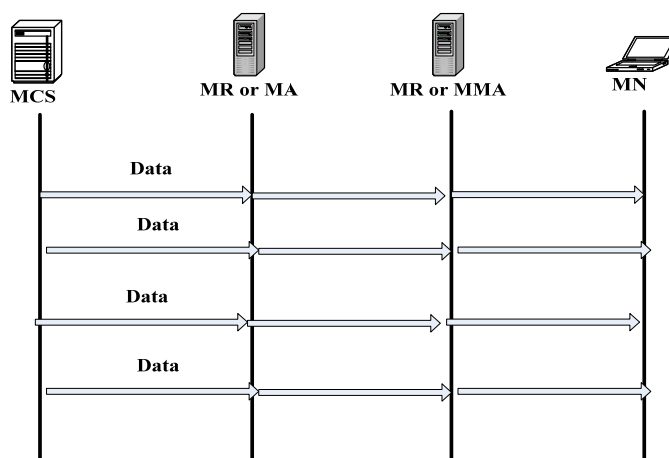

Figure 7 – Multicast data transport

8.3 SESSION JOIN AND LEAVE

Session Join is an operation for enabling a promising user (MN) to join a specific session announced by the service provider. Based on the information of the session and SM as provided in the session announcement, MN will try to join the session.

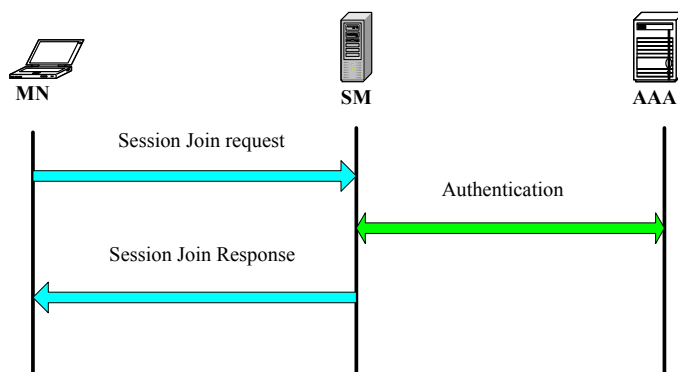

Figure 8 – Session Join in MMC

In Session Join, the promising MN shall first send a session join request message to SM. Note that the contact information of SM (IP address and port number) shall be announced in the session announcement phase. The join request message shall include the following information:

- Session ID;
- User ID.

Upon receipt of the join request message from the promising MN, SM will contact the associated AAS service to check whether it is an authenticated, authorized user or not. The resulting response message, which may include the following information, will be sent to the promising MN by SM:

- Whether the request is accepted or not;
- Others specific to the session, if required.

Some of the active MNs may leave the session before the MCS stops the session.

8.4 CONFIGURATION OF MMC AGENTS

8.4.1 CONFIGURATION OF LOCAL MOBILITY CONTROLLER FOR MULTICASTING

In the Session Join phase in multicast networks, SM shall assign an appropriate LMC (Local Mobility Controller) to MN. The LMC will perform the protocol operations associated with status monitoring and mobility support for MN.

8.4.2 TREE CONFIGURATION FOR OVERLAY MULTICASTING

In a relay multicast network, the parent MA of an MN joining the session shall be configured. This is called “tree configuration for overlay multicasting.” MA will relay multicast data from MCS to MN and perform control operations such as status monitoring, tree reconfiguration, and mobility support for MNs

In case of an overlay multicasting tree configuration, the tree configuration on a mobile network is preceded by the tree configuration on a fixed network since MCS is considered a fixed node in this one-to-many multicasting service.

Considering the tree configuration on a fixed network, each MA performs the session subscription procedure by exchanging subscription messages with SM. Note that the subscription of SMA should precede any subscription by MA since SMA is a root node of the one-to-many data delivery tree.

During the subscription phase, SM gives a list of participating MAs to the newly subscribing MA since the newly subscribing MA does not know to which it should attach itself. With the information given from SM, each MA explores MAs over the overlay multicast tree and determines which MA is the best parent node. Once a decision has been made, the newly subscribing MA tries to attach the candidate parent MA by sending a relay request message.

To improve overlay multicast, each MA may try to find a more optimized parent MA before switching to the more optimized MA. During the overlay multicasting service, each MA performs a self-improvement of the tree. Some additional mechanisms can be used to keep the overlay multicast network robust against network faults such as loop-forming and partitioning.

8.5 STATUS MONITORING

MA/LMC shall monitor the status of active MNs. For this purpose, some control messages may be exchanged between MA/LMC and MN. Each MA/LMC will then aggregate the status information to SM.

The following figure shows an abstract flow of status monitoring in the MMC:

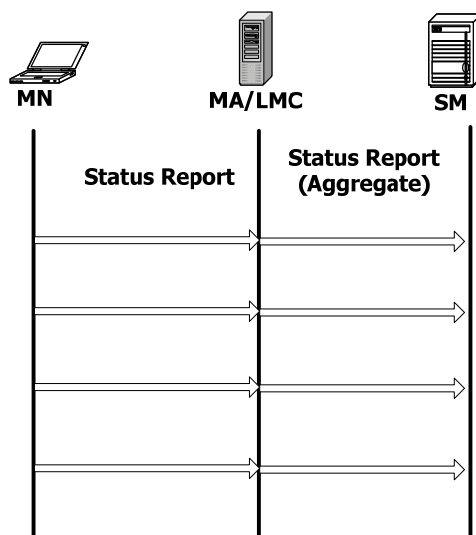

Figure 9 – Status monitoring in MMC

Such status information may usually include the following information:

- MN's ID;
- QoS measurements such as throughput, delay, packet loss rate, etc.

The membership information (MN ID) may be used as charging data by the service provider. On the other hand, the QoS information may also be used for charging by the service provider and for the adjustment of the sending rate of the multicast data by MCS.

8.6 MOBILITY SUPPORT

When MN moves into the other new network region and consequently changes its PoA and IP subnet, MMC handover operations will be executed. Handover signaling operations for handover support may be performed between MN and MMA (or LMC) and between two neighboring MMAs (or LMCs). Handover support is aimed at minimizing the handover latency and data losses during the handover period.

The handover request message may include the following information:

- MN ID;
- Information on the location of the new PoA or IP subnet.

The following figure shows an abstract flow of handover signaling in MMC networks:

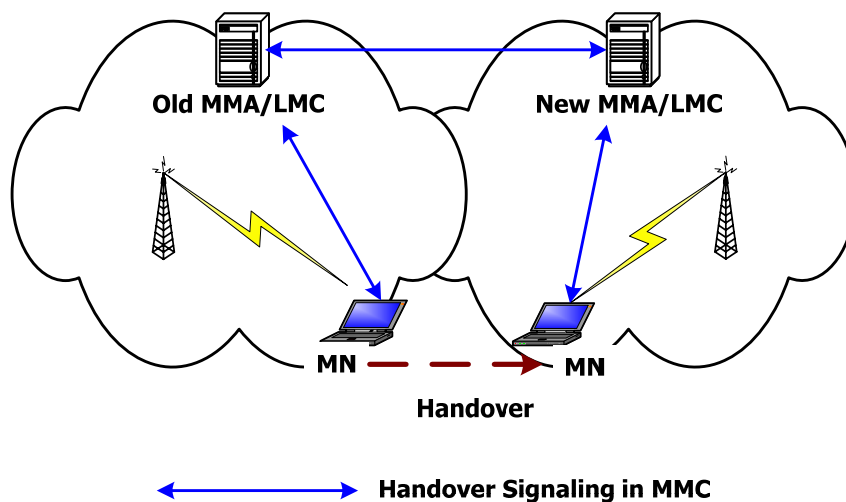

Figure 10 – Handover signaling operations in MMC

As shown in the figure above, the old MMA/LMC may need to communicate with the new MMA/LMC to support seamless handover; this in turn may be helpful in ensuring that MN would not need to perform the re-authentication process in the new access network.

The handover procedures may depend on the type of the underlying network, i.e., multicast or overlay multicast networks. The detailed operations for handover support will be described in the MMC protocol specifications.

APPENDIX A. APPLICABILITY OF MMC PROTOCOLS TO OMA/BCAST

This Appendix describes the applicability of MMC protocols to the OMA/BCAST framework as an example use case.

The figure below shows the abstract architecture of OMA/BCAST for multicasting and broadcasting services over mobile and broadcast networks. The functional entities are illustrated, e.g., BCAST service application, service distribution/adaptation, subscription management, broadcast/interaction networks, and terminal. The figure also shows the interfaces between BCAST functional entities such as BCAST-1, BCAST-2, BDS-1, BDS-2, etc. As shown in the figure, the terminal represents a mobile node in the network; the broadcast network indicates a multicast-enabled wireless/mobile network, whereas the interaction network is a unicast-based network.

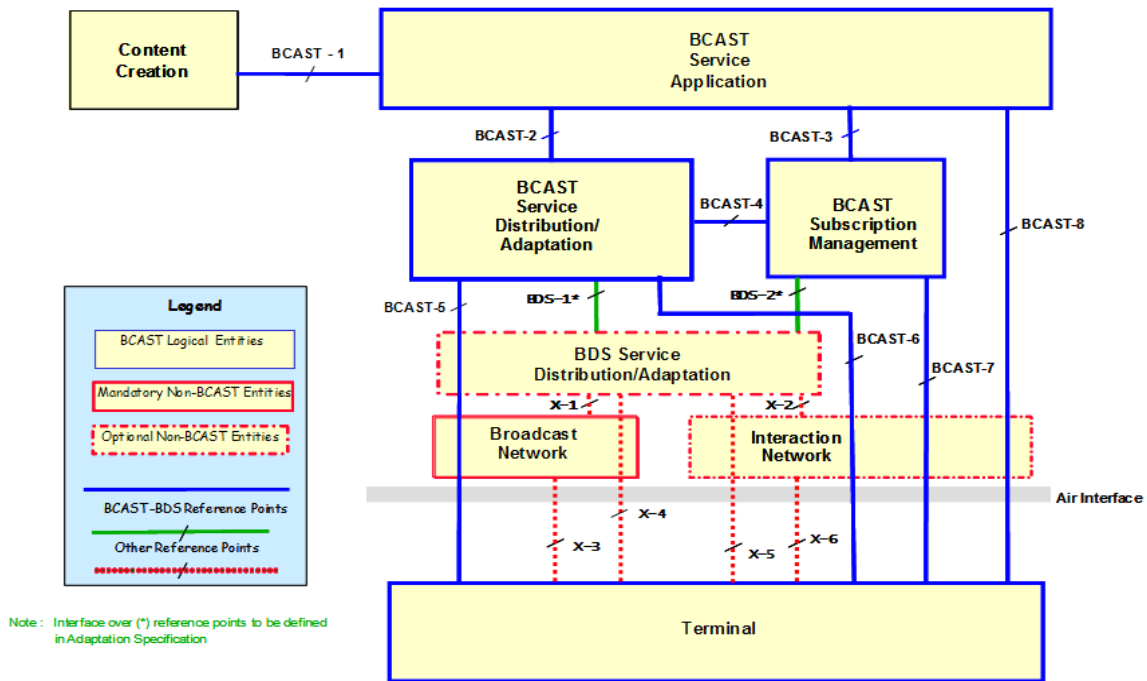

Figure 11 – Overall framework of OMA/BCAST

From the viewpoint of the MMC framework and protocol, the BCAST service application corresponds to a conventional multicast application; the BCAST service distribution/adaptation function can be regarded as a set of MMC MCS (multicast contents server) and SM (session manager). The BCAST subscription management will handle the user profile and database based on the user's subscription. As shown in the figure, IP multicast data transport corresponds to the BCAST-5 interface between the BCAST service distribution/adaptation function and terminal through the broadcast network.

The LMCs of MMC-2 and MMAs of MMC-3 may be implemented in the BDS service distribution/adaptation function as shown between the BCAST service distribution/adaptation function and broadcast network in the figure. These functional entities can be used for session join and status monitoring and handover support for mobile multicasting. In this respect, the MMC-2 protocol may be implemented in the following BCAST interfaces: BDS-1, BDS-2, X-1, X-3, and X-4. On the other hand, the MMC-3 protocol for overlay multicasting may be implemented in the following BCAST interfaces: BDS-1, BDS-2, X-2, X-5, and X-6. Note that other interfaces such as BCAST-1, BCAST-2, and BCAST-3 may be outside the scope of the MMC protocols.

APPENDIX B. BIBLIOGRAPHY

The following Recommendations and International Standards could be used as reference materials that provide useful information for understanding of this Recommendation | International Standard:

- a) ITU-T Recommendation X.601 (2000), Multi-Peer Communications Framework
- b) ITU-T Recommendation X.602 (2004) | ISO/IEC 16511: 2005, Information Technology – Group Management Protocol (GMP)
- c) ITU-T Recommendation X.605 (1998) | ISO/IEC 13252: 1999, Information Technology – Enhanced Communications Transport Service Definition
- d) ITU-T Recommendation X.606 (2001) | ISO/IEC 14476-1: 2002, Information Technology — Enhanced Communications Transport Protocol: Specification of simplex multicast transport
- e) ITU-T Recommendation X.606.1 (2002) | ISO/IEC 14476-2: 2003, Information Technology — Enhanced Communications Transport Protocol: Specification of QoS Management for Simplex Multicast Transport

The following IETF RFCs could be used as reference materials that provide useful information for understanding this Recommendation | International Standard:

- a) IETF RFC 3569, Overview of Source-Specific Multicast(SSM), Informational, July 2003
- b) IETF RFC 3973, Protocol Independent Multicast - Dense Mode (PIM-DM): Protocol Specification (Revised), Experimental, January 2005
- c) IETF RFC 3228, IANA Considerations for IPv4 Internet Group Management Protocol (IGMP), BCP, February 2002
- d) IETF RFC 3171, IANA Guidelines for IPv4 Multicast Address Assignments, BCP, August 2001
- e) IETF RFC 3170, IP Multicast Applications: Challenges and Solutions, Informational, September 2001
- f) IETF RFC 3376, Internet Group Management Protocol: Version 3, Proposed Standard, October 2002

The following 3GPP Technical Specifications could be used as reference materials that provide useful information for understanding of this Recommendation | International Standard:

- a) 3GPP TS 22.246, MBMS User Services, September 2004
- b) 3GPP TS 23.246, MBMS Architecture, June 2005
- c) 3GPP TS 25.346, MBMS in RAN: Stage 2, June 2005
- d) 3GPP TS 26.346, MBMS Protocols and Codecs, June 2005
- e) 3GPP TS 33.246, Security of MBMS, June 2005

The following 3GPP2 documents could be used as reference materials that provide useful information for understanding this Recommendation | International Standard:

- a) 3GPP2 S.R0030-A, Broadcast/Multicast Services – Stage 1, January 2004
 - b) 3GPP2 S.S0083-A, Broadcast Multicast Security Framework, August 2004
 - c) 3GPP2 X.S0022, BCMCS in cdma2000 wireless IP network, December 2004
 - d) 3GPP2 A.S0019, Interoperability Specification for BCMCS, December 2004
 - e) 3GPP2 C.S0054, cdma2000 High Rate BCMCS Packet Data Air Interface Specification, July 2005
-